

Supercutter

Pipe cutting/bevelling machine

- **Range:** 6" - 60" o/d .
- **Functions:** cutting, bevelling, facing, counterboring.
- **Materials:** any kind of steel.
- **Power:** pneumatic/hydraulic.
- **Note:** the SUPERCUTTER range of portable pipe cutting and bevelling machines are ruggedly designed to work in the most arduous conditions. The split frame design enables in-line pipe to be cut and bevelled simultaneously. Various models of machines cover from 6" to 60" diameter. All types of weld prep can be achieved up to 60 mm wall thickness.



TOOL BOXES follow the contour of the pipe to give you an accurate weld prep.



The two upper locking jaws are pre-adjustable upon standard diameters.

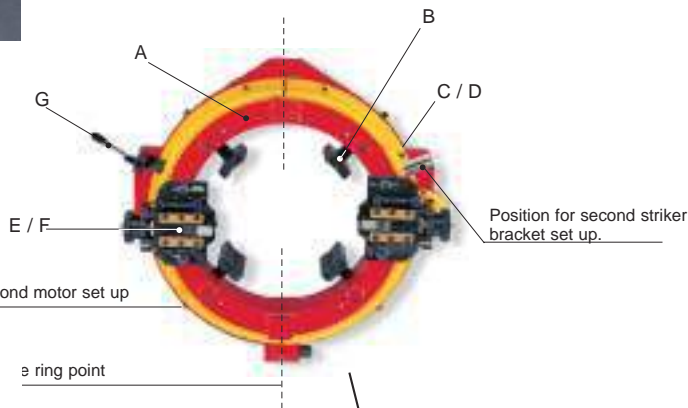

RANGE	SUPPLY	A	B	C	D	E	STANDARD EQUIPMENT				
							F	G	H	I	L
06" - 12"	pneum.	1	4	1		2	opt.	1	opt.		opt.
06" - 12"	hd.	1	4		1	2	opt.	2		opt.	opt.
12" - 18"	pneum.	1	4	1		2	opt.	1	opt.		opt.
12" - 18"	hd.	1	4		1	2	opt.	2		opt.	opt.
18" - 24"	pneum.	1	4	1		2	opt.	1	opt.		opt.
18" - 24"	hd.	1	4		1	2	opt.	2		opt.	opt.
24" - 30"	pneum.	1	4	1		2	opt.	1	opt.		opt.
24" - 30"	hd.	1	4		1	2	opt.	2		opt.	opt.
30" - 36"	pneum.	1	4	1		2	opt.	1	opt.		opt.
30" - 36"	hd.	1	4		1	2	opt.	2		opt.	opt.
36" - 42"	pneum.	1	6	2		2	opt.	1	opt.		opt.
36" - 42"	hd.	1	6		1*	2	opt.	2		opt.	opt.
42" - 48"	pneum.	1	6	2		2	opt.	1	opt.		opt.
42" - 48"	hd.	1	6		1*	2	opt.	2		opt.	opt.
48" - 54"	pneum.	1	6	2		2	opt.	1	opt.		opt.
48" - 54"	hd.	1	6		1*	2	opt.	2		opt.	opt.
54" - 60"	pneum.	1	6	2		2	opt.	1	opt.		opt.
54" - 60"	hd.	1	6		1*	2	opt.	2		opt.	opt.

Note:
Models from 6" to 12" or smaller, now also available on request in lightweight, slim-line aluminium .

- * B clamping pads
- * C pneumatic motor
- * D hydraulic motor
- * E external dancer spring loaded tool boxes
- * F internal dancer spring loaded tool boxes
- * G striker bracket
- H filter lubricator
- I hydraulic power pack
- L coolant tray and pump

* Double motor drive available on request.

* Can be interchangeable with any size machine.

EXAMPLES OF CUTTING AND BEVELLING TOOLS



Supercutter

			SC	SC HD
**	Pneumatic motor power	hp	3,00	-
**	Air consumption	cfm	100/110	-
**	Air working pressure	psi	90	-
**	Hydraulic motor power	hp	-	15
***	Working power	hp	-	8
**	Oil working pressure	psi	-	1500-1700
**	Oil Flow	Lt/min	-	40
*	Radial feed rate per revolution	inches	0,004	0,008
*	Tool box feed	inches	2,36	

mechanical data
** mathematical data
*** average data

RANGE	SUPPLY	RPM	WEIGHT**	"A"	"B"	"C"
06" - 12"	pneum.	26	143	800	750	500
06" - 12"	hd.	26	143	800	750	370
12" - 18"	pneum.	21	175	917	863	500
12" - 18"	hd.	21	175	917	863	370
18" - 24"	pneum.	17	225	1099	1041	500
18" - 24"	hd.	17	225	1099	1041	370
24" - 30"	pneum.	14	270	1255	1193	500
24" - 30"	hd.	14	270	1255	1193	370
30" - 36"	pneum.	12	336	1411	1346	500
30" - 36"	hd.	12	336	1411	1346	370
36" - 42"	pneum.	10	366	1610	1615	500
36" - 42"	hd.	10	366	1610	1615	370
42" - 48"	pneum.	9	410	1760	1770	500
42" - 48"	hd.	9	410	1760	1770	370
48" - 54"	pneum.	8	466	1910	1935	500
48" - 54"	hd.	8	466	1910	1935	370
54" - 60"	pneum.	7	515	2065	2090	500
54" - 60"	hd.	7	515	2065	2090	370

** Net weight of the frame (Kg)

TECHNICAL FEATURES

- All units are supplied complete with all clamping pads to cover the full range of the machine. Service tools, drawings, instruction manual and warranty certificate are also supplied as standard.
- Each machine is supplied with a protective wooden case.
- We strongly recommend the use of a portable filter lubricator with all our pneumatic models.
- Further information available on our hydraulic power pack.

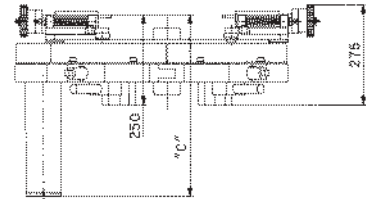

Models from 6" up to 36"

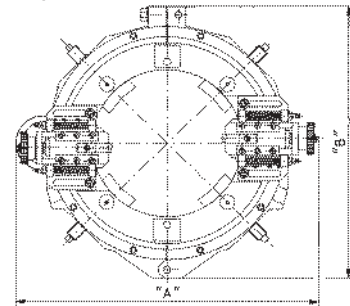

Models from 36" up to 60"

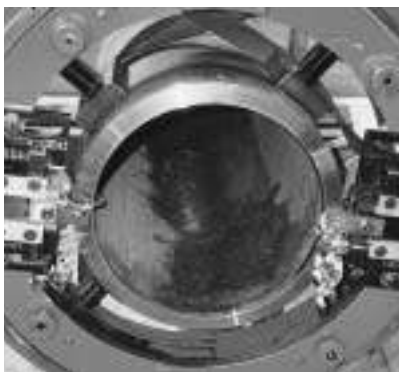
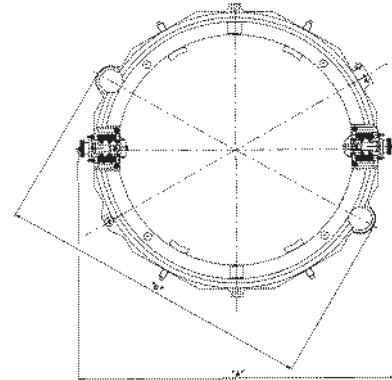
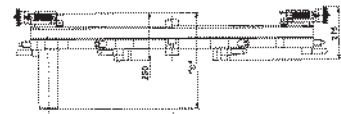

All models have a split frame design to allow a quick set up in any point of the pipe.

OPTIONAL



A hydraulic power pack available with either manual or remote control.

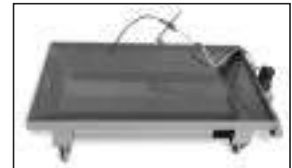

Collecting tray and pump to pass coolant to the cutting area.



15 hp hydraulic motor.