

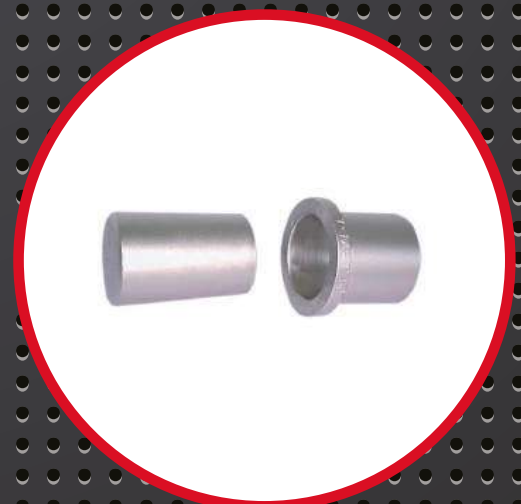

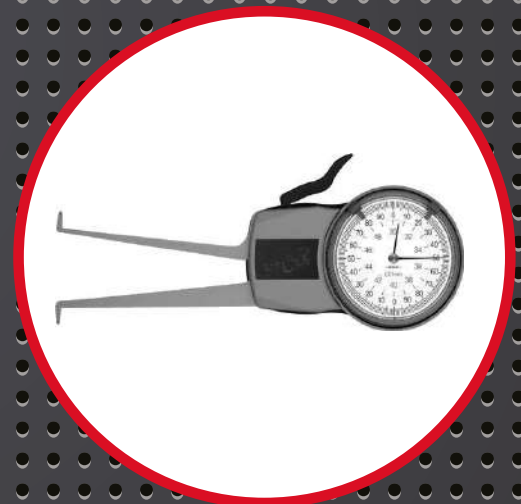

# TUBE TESTING EQUIPMENT

- Pipe Beveling Machines
- Pipe Cutting Machines
- Grinding Machines
- Pipe Stands and Clamps
- Pipe Purging
- Plate Bevellers
- Heat Exchanger, Boiler & Bundle
- Plus so much more....



# JOINT TESTING KIT

GBC Industrial Tools Ltd | 01844 201555 | sales@gbc-uk.com | www.gbc-uk.com 

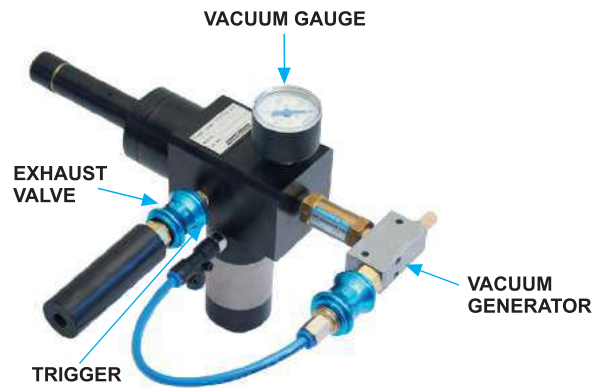

## Features :

- Simple, Quick and Reliable tube joint testing. Test 10 tube joints per minute.
- Interchangeable seal sets : Allows testing of tube joints from 7.75 mm to 30.63 mm ID with easy to replace accessories.
- Joint Testing Gun weights less than 1.5 kg.
- Air supply : Uses standard plant air supplies from 70 psi to 100 psi (4.7 to 6.8 bar).
- Silent during use. Ergonomic design makes testing effortless.
- Each Kit packed in compact and handy case.

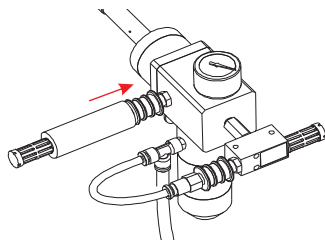

A) Close exhaust valve by sliding to extreme right

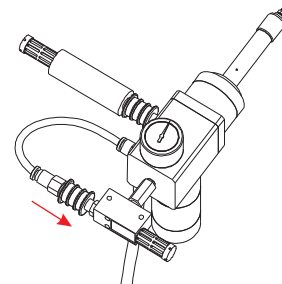

D) Slide vacuum valve to right to start generating vacuum. Gauge will indicate vacuum level.

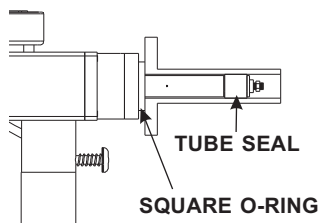

B) Insert manifold till square o-ring firmly sits on tube

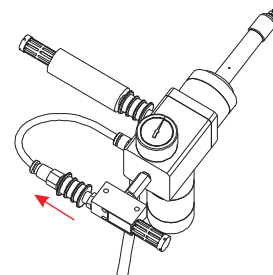

E) Close vacuum slide valve by shifting to left. This will stop vacuum generation. Observe vacuum gauge. Vacuum level falls if the joint is leaking.

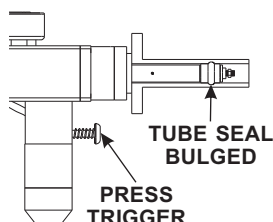

C)

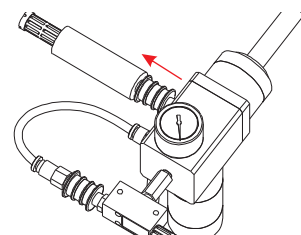

F) After testing the joint release the tube seal by sliding the exhaust to the left. The Joint Testing Kit can be withdrawn after the tube seal collapses.

# JOINT TESTING KIT SPECIFICATIONS

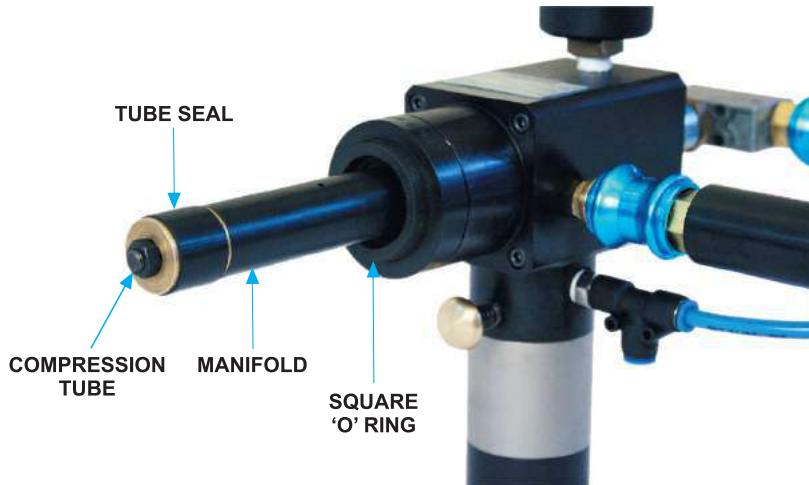

Tube Size		Tube ID Range		Tube Seal Part No.	Tube Seal Diameter		Manifold with Square O ring	Compression Tube Part No.	Square O ring
O.D.	bwg	mm	inch		mm	inch			
5/8"	9	8.37	.330	JTK-300N	7.5	.295	JTM-15-125-5/8	JTK-15-125	JTK-16-5/8
	10-13	9.07 - 11.05	.357 - .435	JTK-370N	9	.354			
	14-15	11.67 - 12.23	.459 - .481	JTK-450N	11.6	.457			
	16-17	12.57 - 12.93	.495 - .509	JTK-470N	12.2	.480			
	18-19	13.39 - 13.75	.527 - .541	JTK-490N	13.3	.523			
	20-24	14.11 - 14.77	.555 - .581	JTK-530N	13.8	.543			
3/4"	9	11.55	.455	JTK-430N	10.8	.425	JTM-15-312-3/4-1	JTK-15-312	JTK-16-3/4
	10 - 11	12.25 - 12.95	.482 - .510	JTK-450N	11.6	.457	JTM-15-125-3/4	JTK-15-125	
	12 - 13	13.53 - 14.23	.532 - .560	JTK-490N	13.3	.523	JTM-15-312-3/4-2	JTK-15-312	
	14 - 15	14.85 - 15.41	.584 - .606	JTK-530N	13.8	.543			
	16 - 17	15.75 - 16.11	.620 - .634	JTK-570N	15.4	.606			
	18 - 24	16.57 - 17.95	.652 - .706	JTK-610N	16.5	.649			
7/8"	8-9	13.84 - 14.72	.544 - .579	JTK-530N	13.8	.543	JTM-15-312-7/8-1	JTK-15-312	JTK-16-7/8
	10-11	15.42 - 16.12	.607 - .635	JTK-570N	15.4	.606			
	12-13	16.7 - 17.4	.657 - .685	JTK-610N	16.5	.649			
	14-17	18.02 - 19.28	.709 - .759	JTK-690N	18	.708	JTM-15-312-7/8-2		
	18-19	19.74 - 20.1	.777 - .791	JTK-740N	19.7	.775			
	20-24	20.46 - 21.12	.805 - .831	JTK-790N	20.1	.791			
1"	8-9	17.02 - 17.9	.670 - .704	JTK-610N	16.5	.649	JTM-15-312-1	JTK-15-312	JTK-16-1
	10-11	18.6 - 19.3	.732 - .760	JTK-690N	18	.708			
	12-13	19.88 - 20.58	.782 - .810	JTK-740N	19.7	.775			
	14-15	21.2 - 21.76	.834 - .856	JTK-790N	20.1	.791			
	16-17	22.1 - 22.46	.870 - .884	JTK-840N	21.7	.854	JTM-15-405-1		
	18-19	22.92 - 23.28	.902 - .916	JTK-870N	22.9	.901			
	20-24	23.64 - 24.3	.930 - .956	JTK-890N	23.3	.917			
1.1/8"	8-9	20.19 - 21.07	.795 - .829	JTK-790N	20.1	.791	JTM-15-312-1.1/8	JTK-15-312	JTK-16-1.1/8
	10-11	21.77 - 22.47	.857 - .884	JTK-840N	21.7	.854	JTM-15-405-1.1/8	JTK-15-405	
	12-13	23.05 - 23.75	.907 - .935	JTK-870N	22.9	.901			
	14-15	24.37 - 24.93	.959 - .981	JTK-890N	23.3	.917			
	16-17	25.27 - 25.63	.994 - 1.009	JTK-980N	25.2	.992			
	18-19	26.09 - 26.45	1.027 - 1.041	JTK-990N	26.0	1.024			
	20-24	26.81 - 27.47	1.055 - 1.081	JTK-1040N	26.8	1.055			
1.1/4"	8-11	23.37 - 25.65	.920 - 1.01	JTK-890N	23.3	.917	JTM-15-405-1.1/4	JTK-15-405	JTK-16-1.1/4
	12-13	26.23 - 26.93	1.032 - 1.060	JTK-990N	26.0	1.024			
	14-17	27.55 - 28.81	1.084 - 1.134	JTK-1090N	27.5	1.082			
	18-24	29.27 - 30.65	1.152 - 1.206	JTK-1100N	29.2	1.149			

# VACUUM LEAK DETECTOR

GBC Industrial Tools Ltd | 01844 201555 | sales@gbc-uk.com | www.gbc-uk.com 



The Vacuum Tube Leak Tester PVLD-3000 is a simple and precise tool used for testing tubes of boilers, condensers and heat exchangers.

It is the fastest and most accurate method of locating leaky tubes for plugging or replacement or installation of new tubes.

It works on the principle of vacuum in which the tool sucks the air from the tube and creates a vacuum to a desired reading on gauge.

Steady reading on gauge indicates NO LEAK.

If the reading on the gauge drops it indicates a tube with a LEAK.

## Features :

- Only one tool necessary for testing multiple tube sizes.
- Built-in easy to read vacuum gauge.
- Multifield exhaust for quiet operation.
- Lightweight and easy to use.

## TUBE SEALS AVAILABLE

Part No.	Tube OD Size
P-760	1/4" (6.3mm) - 3/4" (19.5mm)
P-1250	5/8" (15.9mm) - 1.1/4" (31.7mm)
P-2000	1.1/8" (28.6mm) - 2" (50.8mm)
P-3000	1.7/8" (47.6mm) - 3" (76.2mm)

## OPERATING INSTRUCTIONS

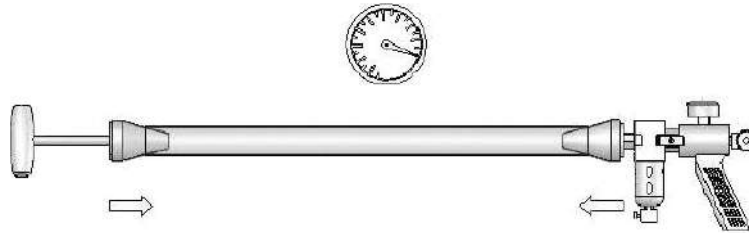

- 1) Connect air supply to the gun Plug both ends of the tube to be tested with Plugging 'T' handle one end and vacuum gun at other end.

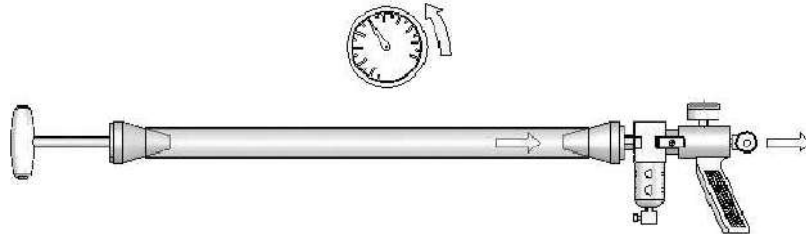

- 2) Operate slide valve and allow creation of a vacuum in the tube.

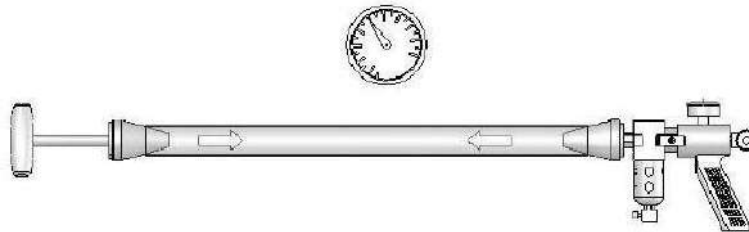

- 3) Shut off the slide valve when vacuum gauge reaches to the desire pressure. Hold for a few seconds. If of gauge shows steady pressure there is no leak.

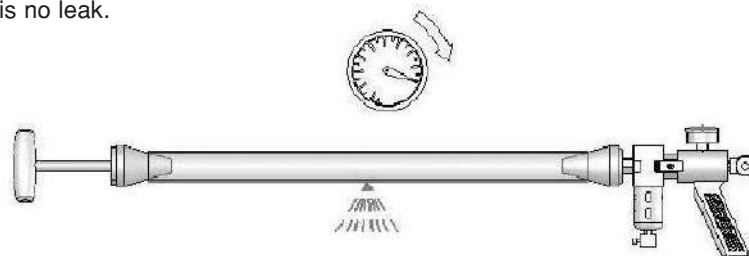

If there is a pressure drop, it indicates a tube with a leak.

## SPECIFICATIONS:

- Covers wide range of tubes with one unit [(tube sizes : 1/4" (6.3mm) to 3" (76.2mm)].
- Requires 90 psi (6.0 bar) compressed air.
- Air consumption : 26 CFM (720l / min).
- Carrying case measures : 16"x12"x4" (410x300x85 mm).
- Tool weight : 4.4 lbs (2 kg).
- Approximate shipping weight : 9.24 lbs (4.2 kg).

# TUBE TESTING GUN SET

GBC Industrial Tools Ltd | 01844 201555 | sales@gbc-uk.com | www.gbc-uk.com 

## INTRODUCTION

Find leaking heat exchangers tubes quickly and easy with the TP0631 Tube Testing Gun Set. It reveals even the smallest tube leak (pinholes). With the Tube Testing Gun Set, you can pneumatically test from 3 to 10 tubes per minute, all with significantly less operator fatigue and greater operator safety. The set comes complete with three rod and tube assemblies to test tubes from 7,2 to 32,5 mm ID.



## OPERATION

Connect the Tube Testing Gun Set to plant air or an inert gas. Insert the Air Injection Gun in one end of the tube, the Plugging gun into the other and press the air control valve. Air expands the seals on both guns and pressurizes the tube. When the pressure in the tube stabilizes, release the air control valve. Any reduction of pressure will be indicated on the integral pressure gauge to reveal even the smallest tube leak. Press the relief control valve to release the pressure out of the tube and the seals on both guns release again.

## FEATURES

- Interchangeable Seal and Washer Sets: allows testing of tubes from 7,2 to 32,5 mm ID.
- Compact and light weight: each gun weighs less than 1kg.
- Uses standard plant air (or gas) supplies from 2,7 to 8,5 bar.
- Standard seal material: neoprene (alternative materials on request).
- Seal holders and washers are made of Stainless Steel to prevent corrosion.
- No leakage after changing the Seal and Washer sets due to the unique sealing element of the seal holders.
- All thread connections are metric or BSP, through which debris and other impurities can be removed easily.

## SEAL SETS

Neoprene seal, complete with washer sets for use with the Tube Testing Gun Set TP0631 (set for the 2 guns).



Partnumber	Tube ID. range	Appropriate seal holder
TPAN5107	7.2 – 8.5 mm	TP – 2031
TPAN5108	8.2 – 9.5 mm	TP – 2031
TPAN5109	9.5 – 10.5 mm	TP – 2031
TPAN5110	10.2 – 11.5 mm	TP – 2031
TPAN5111	11.2 – 12.5 mm	TP – 2031
TPAN5112	12.2 – 13.5 mm	TP – 2031
TPAN5212	12.2 – 13.5 mm	TP – 2081
TPAN5213	13.2 – 14.5 mm	TP – 2081
TPAN5214	14.2 – 15.5 mm	TP – 2081
TPAN5215	15.2 – 16.5 mm	TP – 2081
TPAN5216	16.2 – 17.5 mm	TP – 2081
TPAN5217	17.2 – 18.5 mm	TP – 2081
TPAN5218	18.2 – 19.5 mm	TP – 2081
TPAN5219	19.2 – 20.5 mm	TP – 2081
TPAN5220	20.2 – 21.5 mm	TP – 2081
TPAN5221	21.2 – 22.5 mm	TP – 2081
TPAN5222	22.2 – 23.5 mm	TP – 2081
TPAN5223	23.2 – 24.5 mm	TP – 2081
TPAN5224	24.2 – 25.5 mm	TP – 2081
TPAN5225	25.2 – 26.5 mm	TP – 2081
TPAN5226	26.2 – 27.5 mm	TP – 2081
TPAN5327	27.2 – 28.5 mm	TP – 2101
TPAN5328	28.2 – 29.5 mm	TP – 2101
TPAN5329	29.2 – 30.5 mm	TP – 2101
TPAN5330	30.2 – 31.5 mm	TP – 2101
TPAN5331	31.2 – 32.5 mm	TP – 2101

TPAN refers to the seal set for the tube testing gun set in Neoprene.

## GBC TUBE PLUGS



**ONE PIECE**



**TWO PIECE**

- Tube plugs are designed for sealing off leaking or damaged tubes in heat exchangers, condensers, boilers etc to ensure a uniform joint without damaging the tube sheet.

Tube O.D.		One Piece Tube Plug Model No.	Two Piece Tube Plug Model No.
mm	inch		
9.53	3/8	PLG-375-1	-
12.70	1/2	PLG-500-1	PLG-500-2
15.87	5/8	PLG-625-1	PLG-625-2
19.05	3/4	PLG-750-1	PLG-750-2
22.22	7/8	PLG-875-1	PLG-875-2
25.40	1	PLG-1000-1	PLG-1000-2
31.75	1.1/4	PLG-1250-1	PLG-1250-2
38.10	1.1/2	PLG-1500-1	PLG-1500-2

**Note :** Tube plugs are available in a variety of materials like carbon steel, brass, stainless steel, fibre etc. Specify material needed when ordering.





- **PEDIGREE - 35+ Years Experience**
- **QUALITY - ISO 9001 Since 1996**
- **PERFORMANCE - Guaranteed**